



Izerwaren
Order
numbers

Offset Slam Latches

Stainless steel and zinc

Latch for flush and overlay doors.
Polished chrome die cast zinc
Available in flush, or 1/8, and 3/8 inch offset.

- 88.2319 SET latch and strike flush
- 88.231 Latch only
- 88.232 88.232 strike flush
- 88.234 88.234 strike 1/8"
- 88.236 88.236 strike 3/8"

Latch for flush and overlay doors.
Polished chrome die cast zinc
Available in flush, with 1/8, and 3/8 inch offset

- 88.2389 SET: Latch and strike flush
- 88.238 88.238 latch only
- 88.239 88.239 strike flush
- 88.241 88.241 strike 1/8"
- 88.243 88.243 strike 3/8"

- 88.470 Latch for flush and overlay doors..
- 88.485 Flush strike (depicted)
- 88.486 Offset strike 3/4" offset (not depicted)

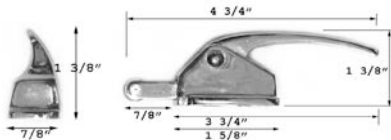

MINI LATCHES



SET: #88.2319 Latch for flush doors with strike. Polished chrome die cast zinc
Base: 1 1/2" x 2 1/8"; Strike 3/4" x 1 1/2". Flush Strike depicted
Available in flush, with 1/8, and 3/8 inch offset.

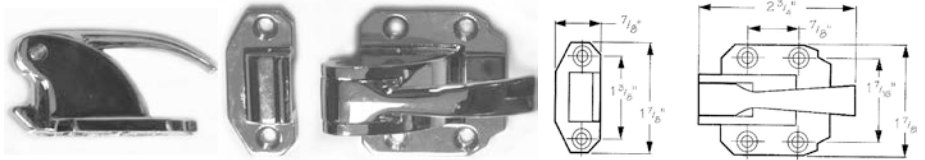

SET: #88.2389 Latch and strike for flush doors. Polished chrome die-cast zinc.
Base: 1 7/8" x 2 3/4"; Strike 7/8" x 1 7/8".
Available in flush, with 1/8, and 3/8 inch offset.

MEDIUM SIZE LATCHES



88.470 Latch for flush and overlay doors. Polished chrome die-cast zinc. Strike sold separate
88.485 Flush strike (depicted)
88.486 Offset strike 3/4" offset (not depicted)

- 88.130 Latch for up lay doors
For flush up to 1/2" inch offset only;
Strike included,
With padlock provision.

STAINLESS STEEL.

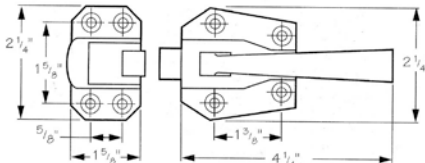

#88.130 Latch for overlay doors with 1/2 inch offset; **stainless steel**, with padlock provision
For flush and 1/2" offset applications
#88.131 for 5/8" to 1 1/4" applications
Base: 2 1/4" x 2 1/2". Strike included

- 88.131 Latch for overlay doors
For 5/8" up to 1 1/4" inch offset only;
Strike included,
With padlock provision

Stainless steel.

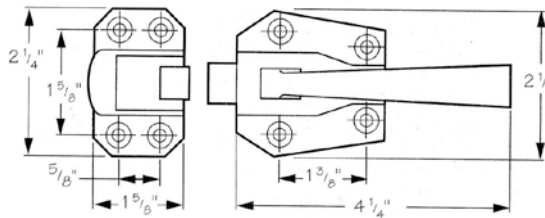

- 42.255 Off set hinge die-cast aluminum
29 x 60 mm; offset 20 mm (3/4 inch)

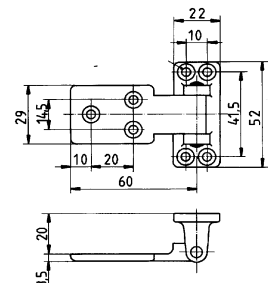

#42.255 door hinge 3/4" offset die-cast aluminum - sizes in mm.



Izerwaren
Order
numbers

Toggle Devices and hatch fasteners
Stainless steel and brass
• seawater resistant

FULL SIZE LATCH 1/2 INCH OFFSET with padlock option

88.163 Latch for up lay doors with 1/2 inch offset; Strike included, with padlock provision **stainless steel**

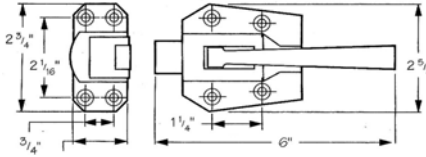

88.163 Latch for up lay doors with 1/2 inch offset; **stainless steel**, with padlock provision Base 2 5/8" x 3" Strike included

FULL SIZE LATCH 1/2 INCH OFFSET AND FLUSH SETUP

88.066 Latch, toggle style, **stainless steel**
88.067 Strike separate polished chrome
Adjustable 5/8 to 1 1/4 inch

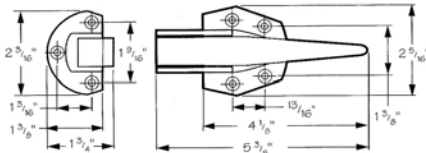

Mechanism 88.066, strike 88.067



#88.066 Latch for up lay doors with 1/2 inch offset; **stainless steel**, with padlock provision Base 2 5/16 inch x 2 3/16 inch" Strike sold separate

#88.067 Strike for offset adjustable 5/8 x 1 1/4 inch

88.067S Strike for flush door application (custom made)



Latch #88.066 with flush strike #88.067S. **Stainless steel**
#88.067S Strike for flush application **stainless steel**

88.100 Latch, full size, for up lay doors; **Stainless steel**, Available with offset: 3/8, 3/4, 1 5/8, 2 1/2 inch



Latch for up lay doors, **stainless steel**
Strike separated

88.001 #88.001 **Pin** for back release (separate)

OVER SIZE LATCH FOR HEAVY DOORS 3/8; 3/4; 1 5/8 & 2 1/2 INCH OFFSET

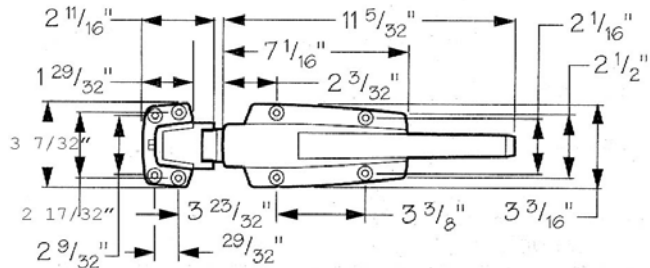
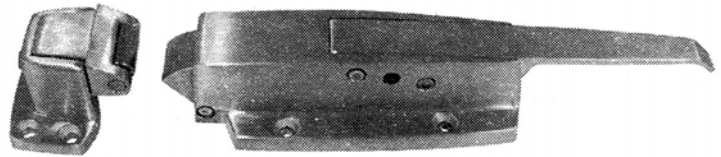

#88.100 Latch for up lay doors; **stainless steel**. Offset: 3/8, 3/4, 1 5/8, 2 1/2 inch.
#88.001 **Pin** for back release (order separate)

42.48105 Strap hinge 1 5/8 offset
13 1/2" x 5"
Stainless steel
Specify LEFT OR RIGHT

FULL SIZE STAINLESS STEEL STRAP HINGES

42.48115 Strap hinge flush
10 3/8" x 4 1/4"
Stainless steel

DETAILS SEE PAGE 4-2-3

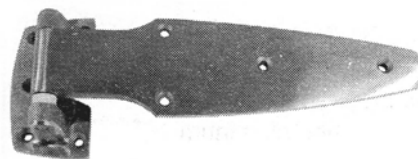

#42.48105 strap hinge 1 5/8 offset
13 1/2" x 5"

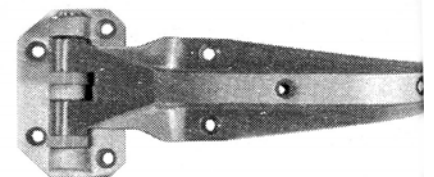

#42.48115 flush strap hinge
10 3/8" x 4 1/4"

Specify LEFT OR RIGHT

More sizes stainless steel strap hinges: See page 4-2-3



Izerwaren
Order
numbers

Hatch hinges, brass and die cast
aluminum and stainless steel

42.255

Hinge each, both handed
Light duty
Polished chrome plated dycast
Offset: 3/4" ~ 20 mm
Overall size: 60 x 52 mm

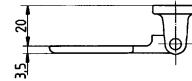
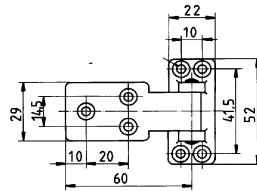

#42.255 door hinge 3/4" offset (20 mm)

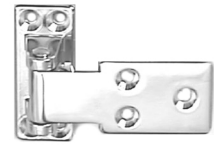

#42.255 Door Hinge 3/4" offset
zinc dycast

42.40119

Hinge each, size: 3 1/2" x 3 1/16"
Medium Duty
Available in flush mounting or
offset.
Offset form 0 to 1 1/8" offset
Polished Chrome Dycast

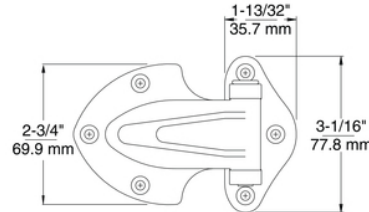

#42.40119; Size: 3 1/2" x 3 1/16" Medium Duty
Available in flush mounting or offset.
Offset from 0 to 1 1/8" offset



#42.40119 size: 3 1/2" x 3 1/16"
Polished chrome diecast

42.273

Hinge each, size: 4 inch leaf;
Heavy Duty
Flush mounting only
SATIN STAINLESS STEEL

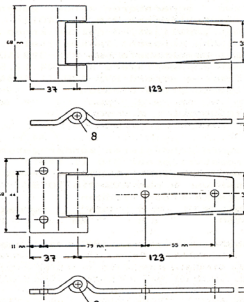

#42.273 with and without holes
Flush mounting only



#42.273; size: 4 inch; Heavy Duty
Available in flush mounting only
SATIN STAINLESS STEEL

42.7294

Hinge each, size: 8 1/4 inch leaf;
Heavy Duty
Flush mounting only
SATIN STAINLESS STEEL

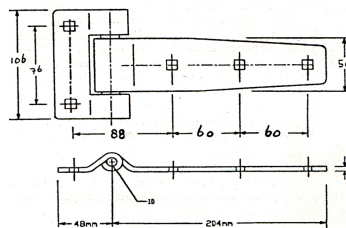

#42.7294 with and without holes
Flush mounting only



#42.7294; size: 9 3/4 inch; Heavy Duty
Available in flush mounting only
SATIN STAINLESS STEEL

42.40233

Hinges strap hinge flush
205 x 137 mm
8 1/8" x 5 13/32"
Chrome Plated Brass

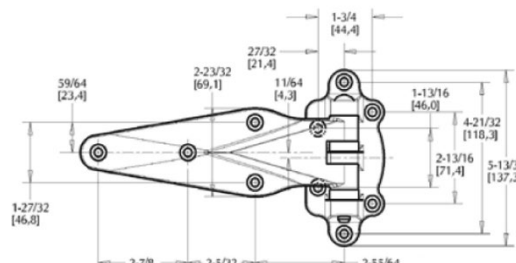

#42.40233 strap hinge flush 205 x 137 mm
8 1/8" x 5 13/32"



#42.40233 strap hinge flush 205 x 137 mm
8 1/8" x 5 13/32"
Polished Chrome Plated Brass



Izerwaren
Order
numbers

Thumb turn latch
316 stainless steel
Seawater resistant

**MARINE THUMB-LATCH
FOR CABINET DOORS**

- 29.612 Thumb-turn latch for refrigerators and cabinets
Latch 43mm or 1 3/4" diameter
Strike included
13 mm high or 1/2" high
Plate: 3.8 mm or
316 Stainless Steel

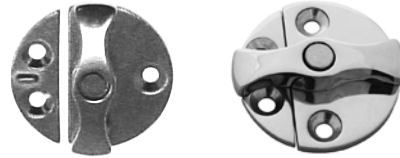

- #29.612
Latch 43mm or 1 3/4" diameter
Strike included
13 mm or 1/2" high

- 29.641 Latch 56 mm or 2-1/4 Diameter
Strike included
15 mm or 9/16" high
Plate 4.5 mm or 3/16" thick

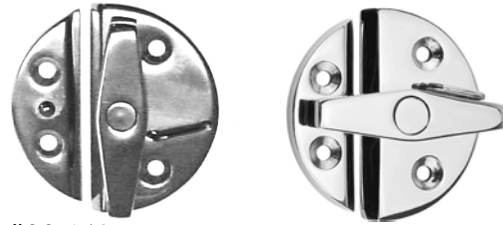

- #29.641
Latch 56 mm or 2-1/4 Diameter
Strike included
15 mm or 9/16" high



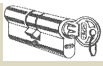

izerwaren
Order
numbers

REFRIGERATOR DOOR LATCH

- 23.374 Refrigerator door latch white
- 23.375 Refrigerator door latch grey

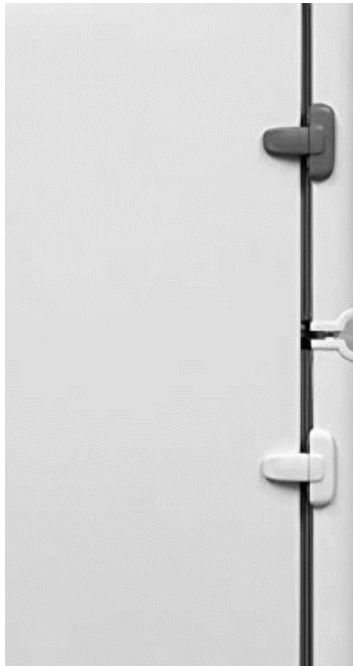

#23.374 refer latch white

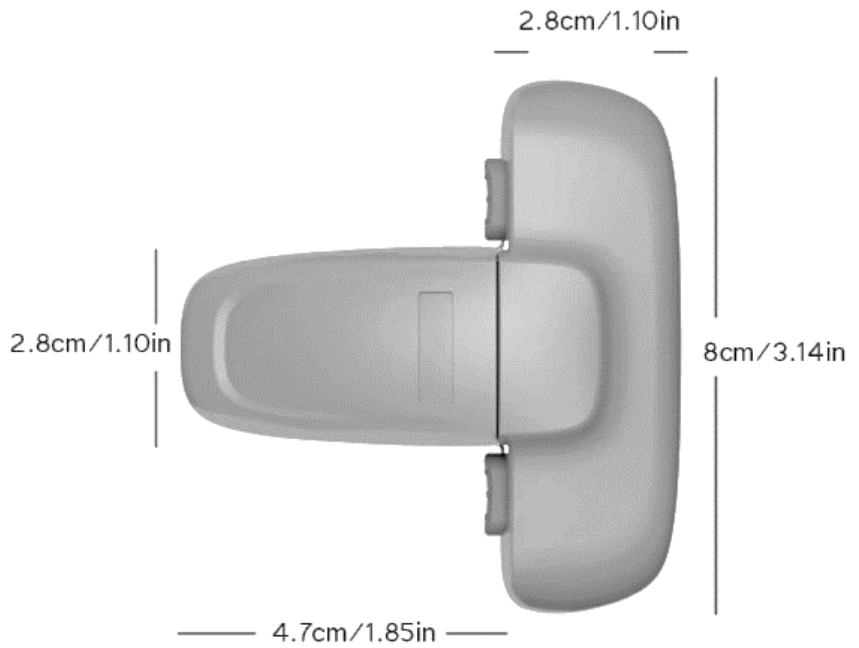

#23.375 refer latch grey.



Depicted 23.374 white

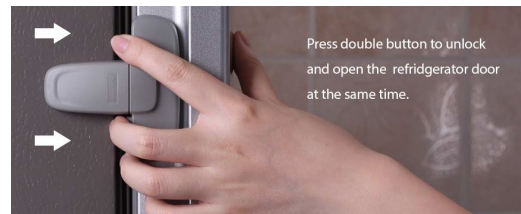

Push buttons simultaneously Two finger operation



Catch has lip for easy installation

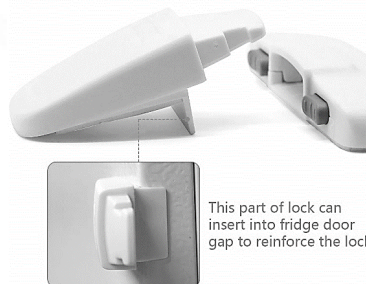

This part of lock can insert into fridge door gap to reinforce the lock



Comes with adhesive tape

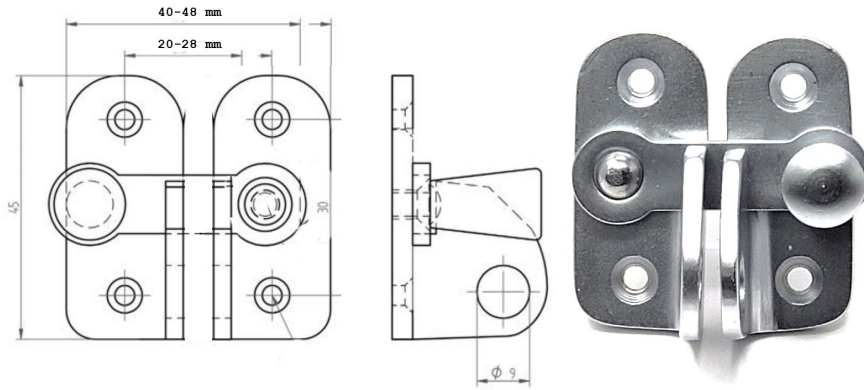
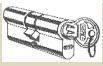

#23.5502 RIGHT HAND DEPICTED door catch with cam - also for refrigerators. (see below) Lockable with padlock.
#23.5501 LEFT HAND door catch with cam.
Sizes: 40 x 45 mm; 1 13/16" x 1 3/4" high x 1 1/8" stand off. Lateral Play: 5/16" or 8 mm. Satin chrome plated brass

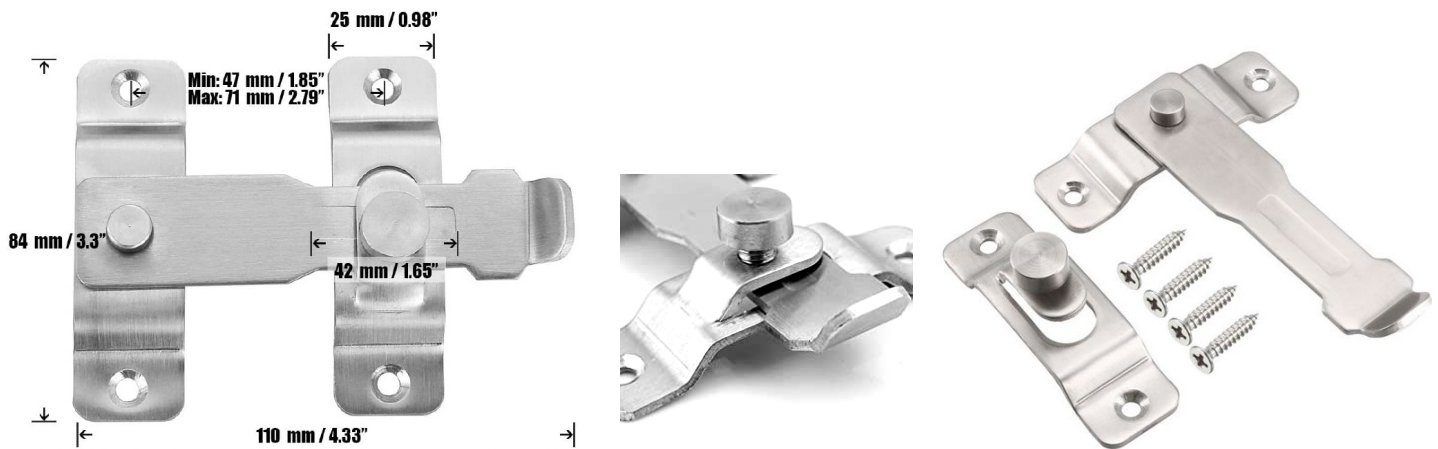

#23.5671 Door Latch 110 mm wide x 84 mm high. Projects 27 mm 1 1/16"; 4 5/8 x 3 5/8 x 1 1/16 inch
With threaded knob to lock down the latch for refrigerators. Satin Stainless Steel.

Showing Details Refrigerator Door Installation:



#23.5501 Door Latch Brass Satin Chrome

#23.5671 Door Latch Satin Stainless Steel

Full size refrigerator latches showing on page 2-8-1